



EDSC-C / EDSC-CC / EDSC-Q

Diffusori a scomparsa per controsoffitto in cartongesso

Hidden diffuser for Gypsum



ecoclima
AIR EVOLUTION





Diffusori in gesso a scomparsa **EDSC-C / EDSC-CC / EDSC-Q**: aria perfetta e design discreto per il massimo comfort.

I diffusori in gesso della serie **EDSC** sono progettati per coloro che desiderano combinare estetica e funzionalità senza compromessi.

Linee pulite, perfetta integrazione nel soffitto e comfort ambientale ai massimi livelli, possono essere verniciate per integrarsi al meglio nei vari ambienti.

EDSC-C / EDSC-CC / EDSC-Q Hidden diffusers for gypsum: perfect air and aesthetic design for maximum comfort.

EDSC gypsum diffusers are designed for those who want to combine aesthetics and functionality without compromise. Clean lines, perfect integration in the ceiling and environmental comfort at the highest level, they can be painted to blend in perfectly with their surrounding.

Aria perfetta, design discreto.

Perfect air, discreet design.

Diffusori adatti sia alla mandata che alla ripresa dell'aria in ambiente dove sia richiesto una elevata resa estetica.

I diffusori **EDSC** si integrano in modo invisibile negli ambienti, garantendo massimo comfort e silenziosità.

EDSC-C / EDSC-Q

Adatti sia per **mandata** che **ripresa**
Suitable for both supply and exhaust



d. 100 mm
d. 125 mm
d. 160 mm



d. 100 mm
d. 125 mm

Materiali e finiture

- Corpo centrale in gesso verniciabile;
- Viti di regolazione in acciaio;
- Guarnizioni siliconiche;

Caratteristiche principali

- Installazione facile e veloce;
- Universali sia per mandata che ripresa;
- Installabili su singola e doppia lastra di cartongesso, e per spessori fuori standard;
- Serranda di regolazione già compresa;
- Imballo sicuro, nessun danneggiamento in fase di trasporto;
- Cavo di sicurezza già compreso;
- Corpo centrale fissato tramite calamite;

Materials and finishes

- Core part in paintable gypsum;
- Steel adjustment screws;
- Silicone gasket;

Main features

- Easy, fast and simple installation;
- Universal for both supply and exhaust air;
- Suitable for single layer, double layer or custom, thickness of plasterboard;
- Regulation damper included;
- Safely packed, never gets damaged during transportation;
- Safety cable included;
- Core body fixed with magnets;

Diffusers suitable for both air supply and return in environments where high quality finish is required.

EDSC diffusers integrate themselves into environments, ensuring maximum comfort and silentness.

EDSC-CC

Ideale per **la diffusione ad effetto coanda**
Ideal for the diffusion with coanda effect



d. **100** mm
d. **125** mm
d. **160** mm

Materiali e finiture

- Corpo centrale in gesso verniciabile;
- Viti di regolazione in acciaio;
- Guarnizioni siliconiche;

Caratteristiche principali

- Installazione facile e veloce;
- Consigliato per l'utilizzo in mandata;
- Installabili su singola e doppia lastra di cartongesso, e per spessori fuori standard;
- Serranda di regolazione già compresa;
- Imballo sicuro, nessun danneggiamento in fase di trasporto;
- Cavo di sicurezza già compreso;
- Corpo centrale fissato tramite calamite;

Materials and finishes

- Core part in paintable gypsum;
- Steel adjustment screws;
- Silicone gasket;

Main features

- Easy, fast and simple installation;
- Recommended for supply air;
- Suitable for single layer, double layer or custom, thickness of plasterboard;
- Regulation damper included;
- Safely packed, never gets damaged during transportation;
- Safety cable included;
- Core body fixed with magnets;



EDSC-C



Diametro Diameter	Dati tecnici Technical Data	D0	D1	D2	D3	D4	D5	D6	D7																
100 MM	Portata Mandata AirFlow Supply	72	88	106	58	77	93	50	66	82	40	52	65	38	47	60	37	45	57	33	41	52	n/d	n/d	n/d
	Perdite di carico Pressure drop	15	25	57	16	27	62	22	40	75	50	84	135	80	115	160	110	150	198	350	400	520	n/d	n/d	n/d
	Portata ripresa AirFlow Exhaust	72	88	105	72	87	103	69	84	105	62	78	94	54	70	86	48	62	77	33	40	50	n/d	n/d	n/d
	Perdite di carico Pressure drop	13	22	40	20	30	63	29	50	100	56	105	171	110	170	270	170	220	370	400	510	650	n/d	n/d	n/d
125 MM	Portata Mandata AirFlow Supply	56	67	77	49	57	68	47	56	65	45	52	60	38	44	52	27	35	42	14	27	31	8	15	19
	Perdite di carico Pressure drop	14	19	28	14	19	27	15	21	27	16	22	29	17	23	31	12	18	27	22	20	30	20	30	45
	Portata Ripresa AirFlow exhaust	88	102	123	53	64	78	51	60	70	42	51	60	37	45	54	27	32	39	26	29	36	8	11	18
	Perdite di carico Pressure drop	17	24	35	12	17	26	14	19	28	14	18	26	15	21	30	12	17	25	15	21	30	30	39	50
160 MM	Portata Mandata AirFlow Supply	92	115	125	89	105	120	78	91	117	71	83	99	69	80	91	51	61	73	47	53	61	15	21	25
	Perdite di carico Pressure drop	14	25	27	14	23	27	13	20	27	14	21	27	16	19	30	14	19	29	16	20	30	16	20	35
	Portata Ripresa AirFlow exhaust	142	155	180	140	150	175	120	145	165	108	127	158	100	115	137	75	90	108	51	61	71	30	34	43
	Perdite di carico Pressure drop	22	30	40	22	30	40	20	28	39	20	28	40	24	32	46	25	32	50	29	41	60	52	80	110
Potenza sonora Sound power		20	25	30	20	25	30	20	25	30	20	25	30	20	25	30	20	25	30	20	25	30	20	25	30

Dati di funzionamento

m³/h portata aria
Pa perdite di carico
dB(A) indice di rumorosità

Operating data

m³/h air flow rate
Pa pressure drop
dB(A) noise level

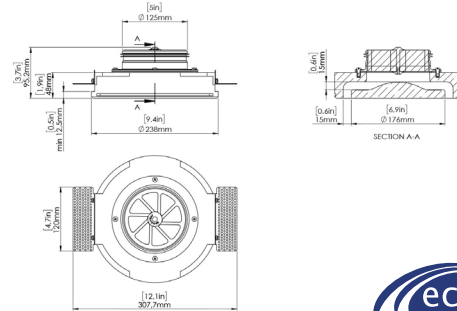
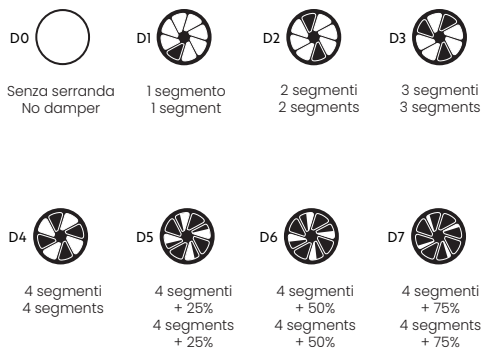
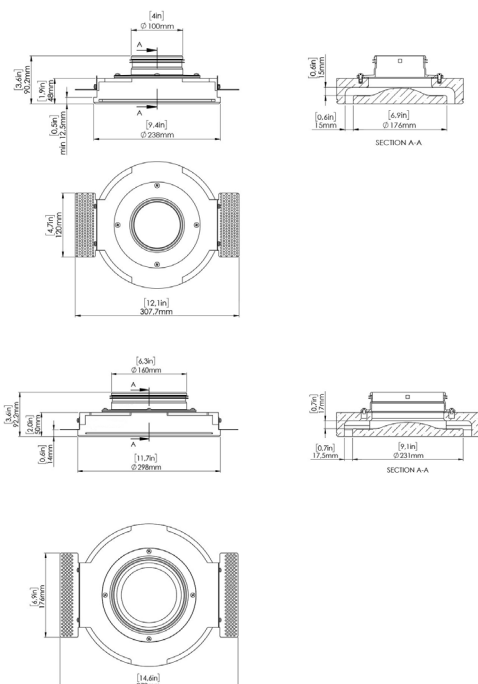

EDSC-CC



Diametro Diameter	Dati tecnici Technical Data	D0		D1		D2		D3		D4		D5		D6		D7									
100 MM	Portata Mandata AirFlow Supply	52	61	74	37	48	58	35	40	47	31	40	46	20	25	30	15	19	22	11	14	16	n/d	n/d	n/d
	Perdite di carico Pressure drop	15	20	28	23	28	33	32	31	57	27	26	31	19	30	43	45	57	77	110	140	200	n/d	n/d	n/d
	Portata ripresa AirFlow Exhaust	88	98	115	45	50	62	34	41	50	30	43	52	29	35	41	18	21	28	13	18	21	n/d	n/d	n/d
	Perdite di carico Pressure drop	23	37	51	22	28	38	25	46	65	29	60	91	33	72	95	35	52	93	97	154	220	n/d	n/d	n/d
125 MM	Portata Mandata AirFlow Supply	72	86	99	52	64	78	50	58	69	46	53	62	29	37	44	24	28	32	17	19	22	8	10	13
	Perdite di carico Pressure drop	14	19	26	13	17	26	13	12	23	14	13	16	9	14	21	13	19	25	17	26	37	27	37	51
	Portata Ripresa AirFlow exhaust	120	136	162	63	72	88	49	60	72	44	58	70	42	51	60	29	34	41	22	24	28	9	12	14
	Perdite di carico Pressure drop	22	35	49	13	28	40	13	25	38	14	29	42	14	30	42	14	20	39	20	34	49	50	75	115
Potenza sonora Sound power		20	25	30	20	25	30	20	25	30	20	25	30	20	25	30	20	25	30	20	25	30	20	25	30

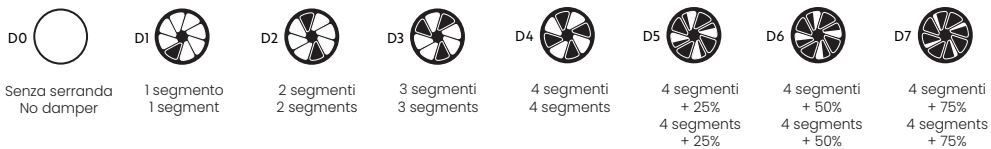

Dati di funzionamento

m^3/h portata aria
 Pa perdite di carico
 $dB(A)$ indice di rumorosità

Operating data

m^3/h air flow rate
 Pa pressure drop
 $dB(A)$ noise level

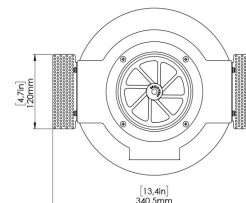
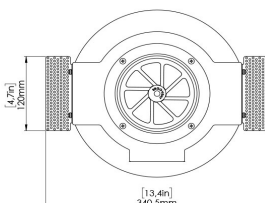
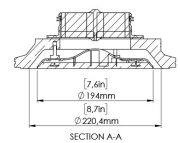
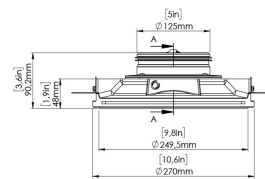
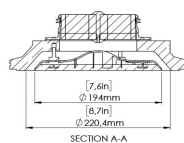
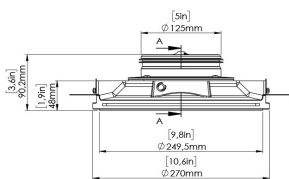

EDSC-Q



Diametro Diameter	Dati tecnici Technical Data	D0		D1		D2		D3		D4		D5		D6		D7									
100 MM	Portata Mandata AirFlow Supply	75	90	108	51	65	81	29	58	70	40	51	62	37	48	57	35	42	52	32	41	49	n/d	n/d	n/d
	Perdite di carico Pressure drop	14	22	30	23	27	40	45	40	49	42	58	75	55	75	100	90	135	180	250	400	600	n/d	n/d	n/d
	Portata ripresa AirFlow Exhaust	77	91	110	69	84	102	61	78	94	53	69	88	48	62	175	42	43	54	28	38	49	n/d	n/d	n/d
	Perdite di carico Pressure drop	13	13	29	26	35	50	37	48	83	49	75	130	65	100	80	85	130	175	190	300	512	n/d	n/d	n/d
125 MM	Portata Mandata AirFlow Supply	75	90	108	61	79	96	52	68	84	47	60	75	44	55	69	41	50	63	37	45	58	34	41	52
	Perdite di carico Pressure drop	12	20	32	14	23	35	18	26	40	23	30	45	27	37	51	35	48	70	50	75	105	160	200	500
	Portata Ripresa AirFlow exhaust	75	90	108	74	98	108	74	96	104	70	85	102	66	82	99	61	55	93	52	67	83	35	42	54
	Perdite di carico Pressure drop	13	20	37	17	25	40	20	27	45	24	35	52	27	40	70	35	77	110	52	100	190	150	220	360
Potenza sonora Sound power		20	25	30	20	25	30	20	25	30	20	25	30	20	25	30	20	25	30	20	25	30	20	25	30

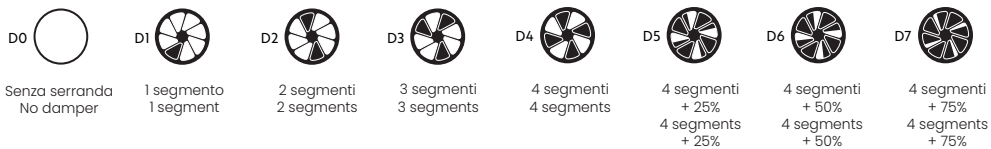

Dati di funzionamento

m^3/h portata aria
 Pa perdite di carico
 dB(A) indice di rumorosità

Operating data

m^3/h air flow rate
 Pa pressure drop
 dB(A) noise level

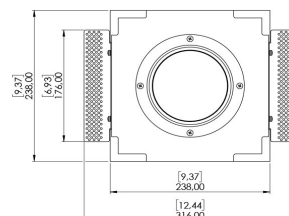
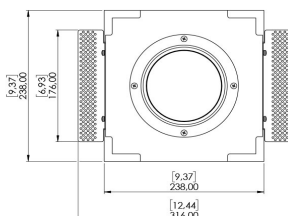
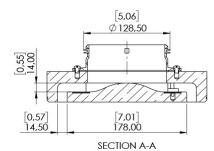
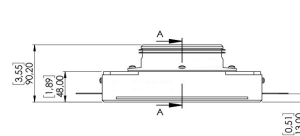
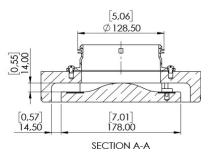
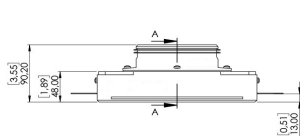

L'aria giusta, dove serve. Pronti ad adattarsi a ogni spazio.

The right air, where it's needed. Ready to adapt to any space.

CARATTERISTICHE DEL LANCIO

AIR THROW

Massima flessibilità nella distribuzione dell'aria, grazie alla regolazione interna dei deflettori della serranda di regolazione, nella versione EDSC-CC il flusso viene orientato lateralmente per una diffusione uniforme lungo il soffitto con effetto coanda. Le diverse configurazioni di lancio consentono di ottimizzare comfort, silenziosità e qualità dell'aria, offrendo una soluzione perfettamente adattabile a ogni progetto.

Maximum flexibility in air distribution, thanks to the internal diffuser adjustment of the deflectors; the airflow can be directed laterally for uniform ceiling diffusion with coanda effect, vertically for direct coverage or at an angle to serve specific areas. The different air throw configurations optimize comfort, quiet operation, and indoor air quality, providing a solution perfectly adaptable to any project.

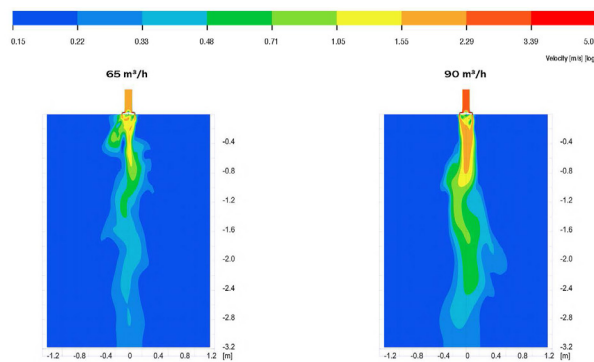

EDSC-C 100/125

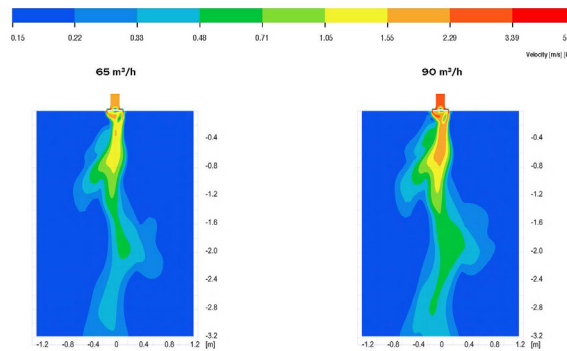

EDSC-C 100/125

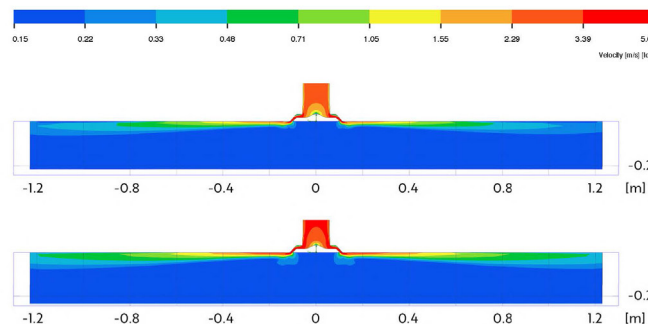

85 m³/h

120 m³/h

EDSC-CC 100/125

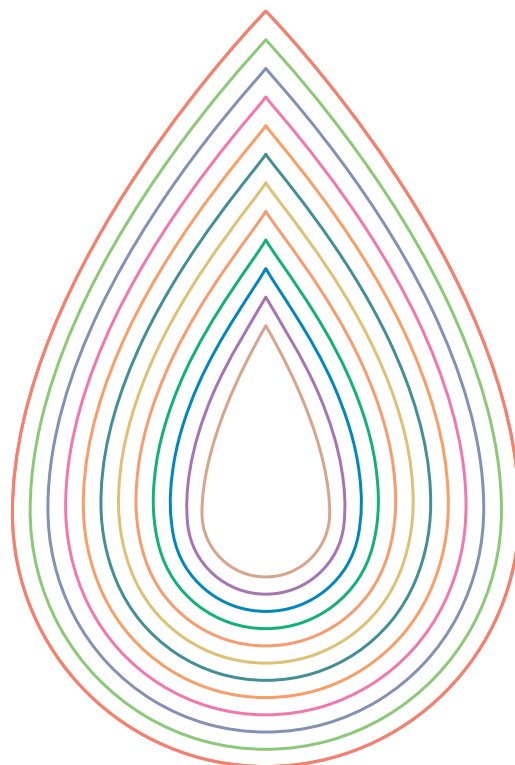

Air Evolution. Tecnologia naturale.

Air Evolution. Natural Technology

Ecoclimate Srl è il partner ideale per i professionisti del trattamento dell'aria. Da oltre 35 anni offre una gamma completa di prodotti e soluzioni per ogni esigenza, dal residenziale all'industriale.

Un approccio che chiamiamo "Natural Technology": tecnologia evoluta e rispetto per l'ambiente, per migliorare il comfort e l'efficienza degli spazi in cui viviamo e lavoriamo.

Con Ecoclimate, l'evoluzione dell'aria diventa realtà.

Ecoclimate Srl is the ideal partner for air treatment professionals.

For over 35 years it has offered a complete range of products and solutions for every need, from residential to industrial.

An approach we call "Natural Technology": advanced technology and respect for the environment, to improve the comfort and efficiency of the spaces in which we live and work.

With Ecoclimate, the evolution of air becomes reality.

Ecoclimate declina ogni responsabilità relativa ad eventuali inesattezze contenute in questo catalogo se dovute ad errori di stampa e trascrizione. Ecoclimate si riserva il diritto di apportare, in qualsiasi momento e senza preavviso, tutte le modifiche tecniche, estetiche e funzionali ai prodotti che ritiene opportune per il miglioramento degli stessi. Modelli, immagini e soluzioni tecniche presentati in questo catalogo sono tutelati da titoli di proprietà industriale. Tutti i diritti sono riservati. È vietata ogni forma di riproduzione anche parziale.

Ecoclimate declines all responsibility for any inaccuracies contained in this catalogue if due to printing or transcription errors. Ecoclimate reserves the right to make, at any time and without prior notice, any technical, aesthetic and functional modifications to its products deemed necessary for their improvement. The models, images and technical solutions presented in this catalogue are protected by industrial property rights. All rights reserved. Any form of reproduction, even partial, is prohibited.



Head quarter

ECOCLIMA SRL
Via Caduti di Russia, 19
35010 Curtarolo - PADOVA - ITALY
P. +39 049 9620344
info@ecoclima.com

Sales office Italy
info@ecoclima.com

Sales office international
francesca@ecoclima.com

ecoclima.com    



ISO 9001
ISO 50001
ISO 45001
ISO 14001

Certified Management System