



# EDSC-C / EDSC-CC / EDSC-Q

Diffusori a scomparsa per controsoffitto in cartongesso

**Scheda tecnica**

Rev.00

  
AIR EVOLUTION

Diametro Diameter	Dati tecnici Technical Data	D0		D1		D2		D3		D4		D5		D6		D7									
100 MM	Portata mandata m <sup>3</sup> /h	72	88	106	58	77	93	50	66	82	40	52	65	38	47	60	37	45	57	33	41	52	n/d	n/d	n/d
	Perdite di carico Pa	15	25	57	16	27	62	22	40	75	50	84	135	80	115	160	110	150	198	350	400	520	n/d	n/d	n/d
	Portata ripresa m <sup>3</sup> /h	72	88	105	72	87	103	69	84	105	62	78	94	54	70	86	48	62	77	33	40	50	n/d	n/d	n/d
	Perdite di carico Pa	13	22	40	20	30	63	29	50	100	56	105	171	110	170	270	170	220	370	400	510	650	n/d	n/d	n/d
125 MM	Portata mandata m <sup>3</sup> /h	56	67	77	49	57	68	47	56	65	45	52	60	38	44	52	27	35	42	14	27	31	8	15	19
	Perdite di carico Pa	14	19	28	14	19	27	15	21	27	16	22	29	17	23	31	12	18	27	22	20	30	20	30	45
	Portata ripresa m <sup>3</sup> /h	88	102	123	53	64	78	51	60	70	42	51	60	37	45	54	27	32	39	26	29	36	8	11	18
	Perdite di carico Pa	17	24	35	12	17	26	14	19	28	14	18	26	15	21	30	12	17	25	15	21	30	30	39	50
160 MM	Portata mandata m <sup>3</sup> /h	92	115	125	89	105	120	78	91	117	71	83	99	69	80	91	51	61	73	47	53	61	15	21	25
	Perdite di carico Pa	14	25	27	14	23	27	13	20	27	14	21	27	16	19	30	14	19	29	16	20	30	16	20	35
	Portata ripresa m <sup>3</sup> /h	142	155	180	140	150	175	120	145	165	108	127	158	100	115	137	75	90	108	51	61	71	30	34	43
	Perdite di carico Pa	22	30	40	22	30	40	20	28	39	20	28	40	24	32	46	25	32	50	29	41	60	52	80	110
<b>Potenza sonora dB (A)</b>		20	25	30	20	25	30	20	25	30	20	25	30	20	25	30	20	25	30	20	25	30	20	25	30

m<sup>3</sup>/h portata aria  
Pa perdite di carico  
dB(A) potenza sonora

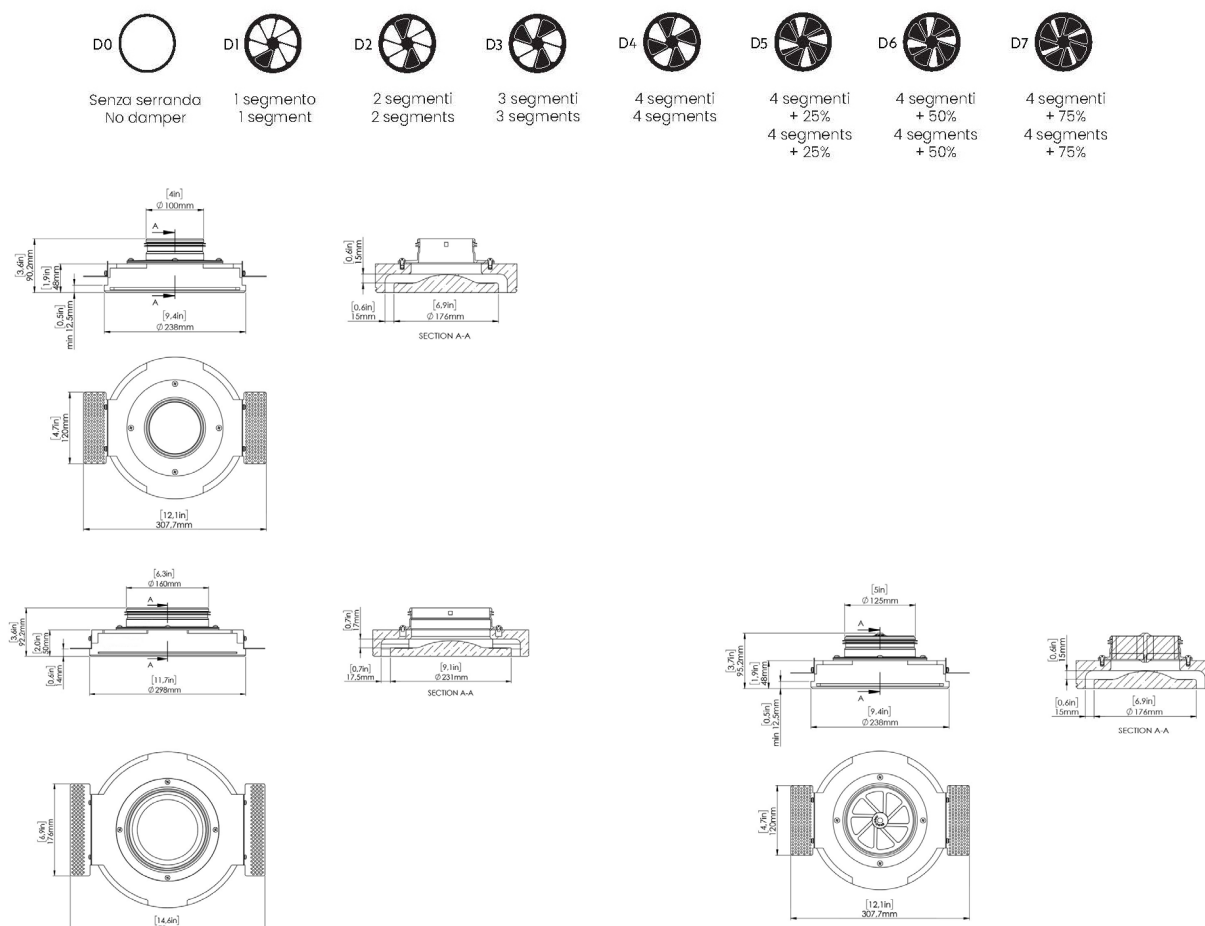

## EDSC-C 100 MANDATA

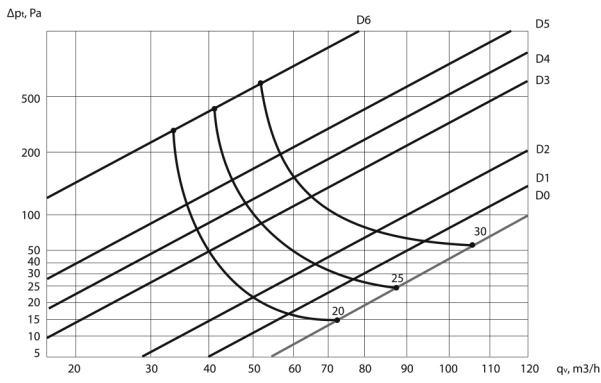

## EDSC-C 100 RIPRESA

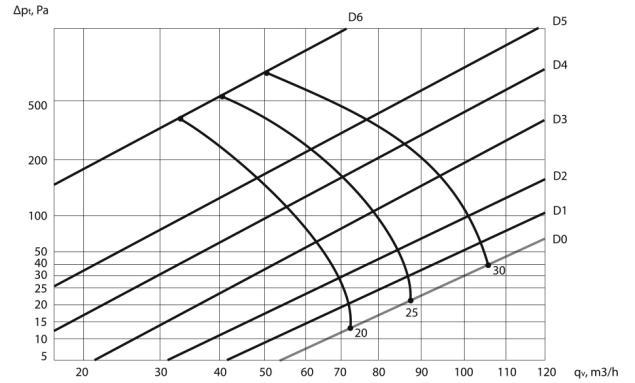

## EDSC-C 125 MANDATA

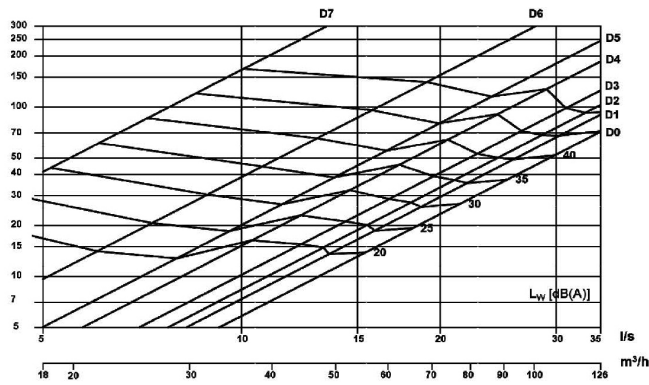

## EDSC-C 125 RIPRESA

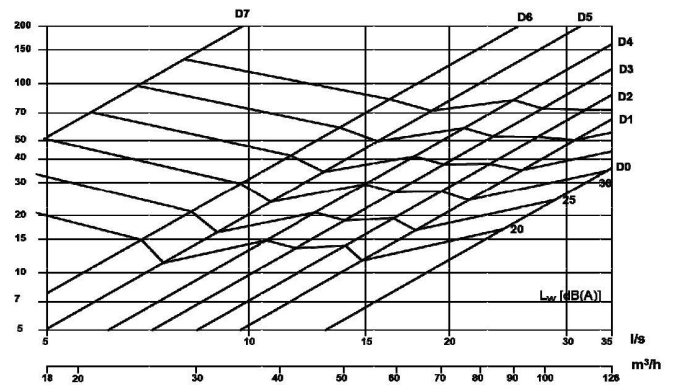

## EDSC-C 160 MANDATA

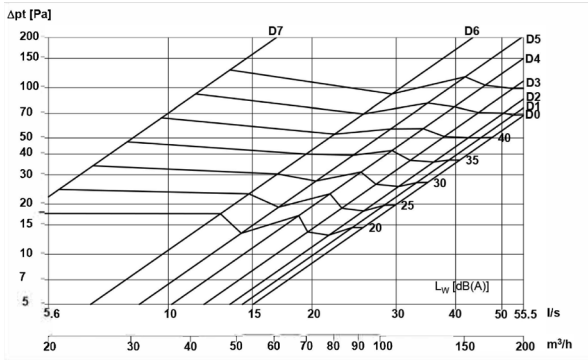

## EDSC-C 160 RIPRESA

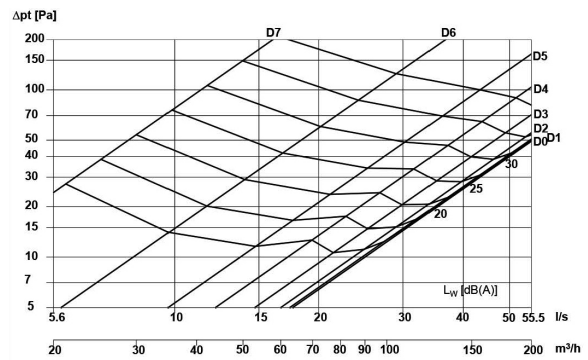

## EDSC-C 100/125 LANCIO

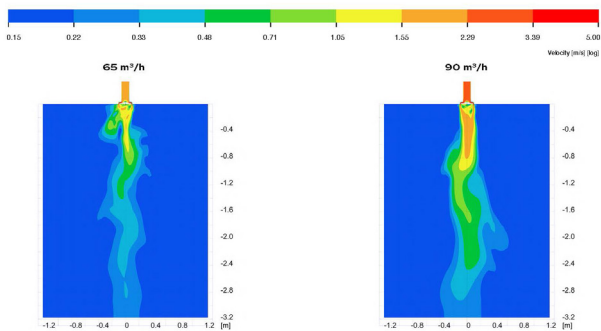

## EDSC-C 160 LANCIO

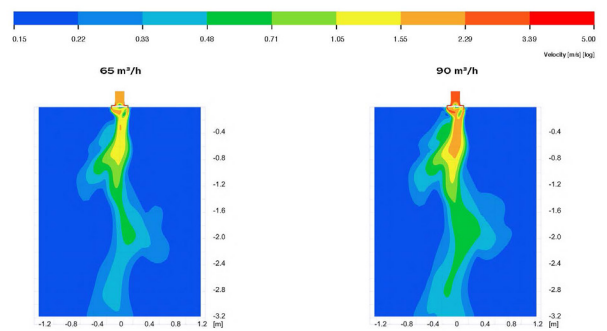

Diametro	Dati tecnici	D0	D1	D2	D3	D4	D5	D6	D7																
100 MM	Portata mandata m³/h	52	61	74	37	48	58	35	40	47	31	40	46	20	25	30	15	19	22	11	14	16	n/d	n/d	n/d
	Perdite di carico Pa	15	20	28	23	28	33	32	31	57	27	26	31	19	30	43	45	57	77	110	140	200	n/d	n/d	n/d
	Portata ripresa m³/h	88	98	115	45	50	62	34	41	50	30	43	52	29	35	41	18	21	28	13	18	21	n/d	n/d	n/d
	Perdite di carico Pa	23	37	51	22	28	38	25	46	65	29	60	91	33	72	95	35	52	93	97	154	220	n/d	n/d	n/d
125 MM	Portata mandata m³/h	72	86	99	52	64	78	50	58	69	46	53	62	29	37	44	24	28	32	17	19	22	8	10	13
	Perdite di carico Pa	14	19	26	13	17	26	13	12	23	14	13	16	9	14	21	13	19	25	17	26	37	27	37	51
	Portata ripresa m³/h	120	136	162	63	72	88	49	60	72	44	58	70	42	51	60	29	34	41	22	24	28	9	12	14
	Perdite di carico Pa	22	35	49	13	28	40	13	25	38	14	29	42	14	30	42	14	20	39	20	34	49	50	75	115
Potenza sonora dB (A)		20	25	30	20	25	30	20	25	30	20	25	30	20	25	30	20	25	30	20	25	30	20	25	30

m³/h portata aria  
Pa perdite di carico  
dB(A) potenza sonora

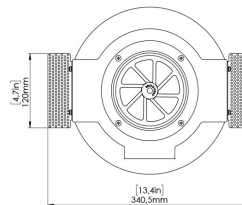
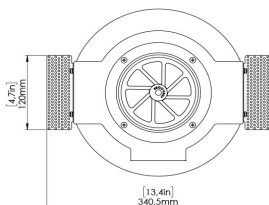
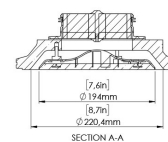
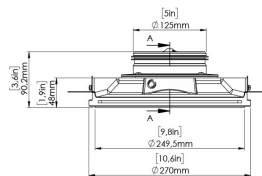
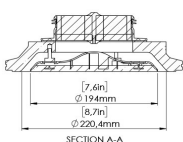
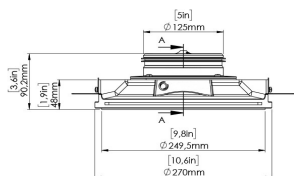
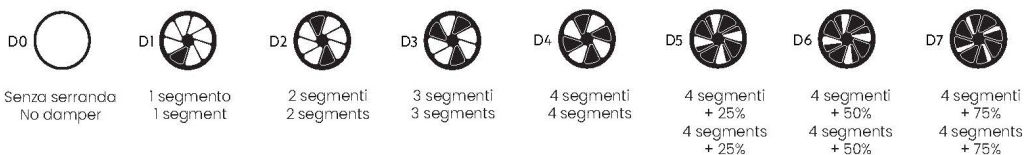

## EDSC-CC 125 MANDATA

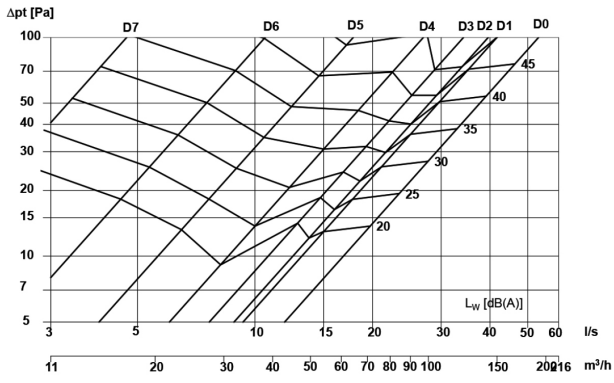

## EDSC-CC 125 RIPRESA

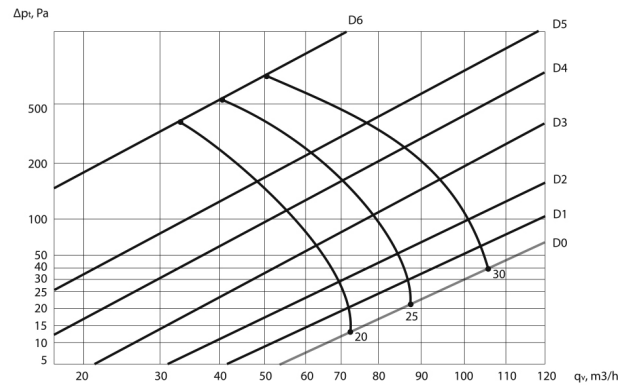

## EDSC-CC 125 LANCIO



85 m<sup>3</sup>/h

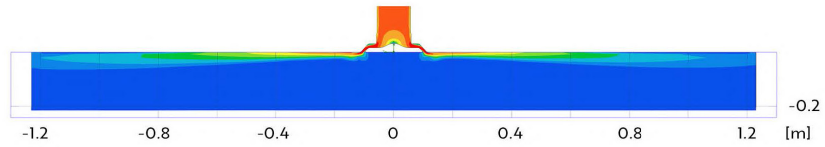

120 m<sup>3</sup>/h

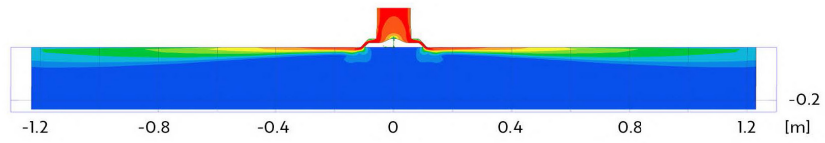

Diametro	Dati tecnici	D0		D1		D2		D3		D4		D5		D6		D7									
100 MM	Portata mandata m <sup>3</sup> /h	75	90	108	51	65	81	29	58	70	40	51	62	37	48	57	35	42	52	32	41	49	n/d	n/d	n/d
	Perdite di carico Pa	14	22	30	23	27	40	45	40	49	42	58	75	55	75	100	90	135	180	250	400	600	n/d	n/d	n/d
	Portata ripresa m <sup>3</sup> /h	77	91	110	69	84	102	61	78	94	53	69	88	48	62	175	42	43	54	28	38	49	n/d	n/d	n/d
	Perdite di carico Pa	13	13	29	26	35	50	37	48	83	49	75	130	65	100	80	85	130	175	190	300	512	n/d	n/d	n/d
125 MM	Portata mandata m <sup>3</sup> /h	75	90	108	61	79	96	52	68	84	47	60	75	44	55	69	41	50	63	37	45	58	34	41	52
	Perdite di carico Pa	12	20	32	14	23	35	18	26	40	23	30	45	27	37	51	35	48	70	50	75	105	160	200	500
	Portata ripresa m <sup>3</sup> /h	75	90	108	74	98	108	74	96	104	70	85	102	66	82	99	61	55	93	52	67	83	35	42	54
	Perdite di carico Pa	13	20	37	17	25	40	20	27	45	24	35	52	27	40	70	35	77	110	52	100	190	150	220	360
Potenza sonora dB (A)		20	25	30	20	25	30	20	25	30	20	25	30	20	25	30	20	25	30	20	25	30	20	25	30

m<sup>3</sup>/h portata aria  
Pa perdite di carico  
dB(A) potenza sonora

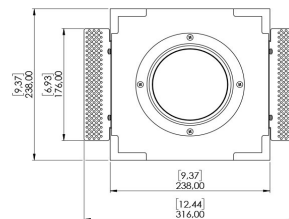
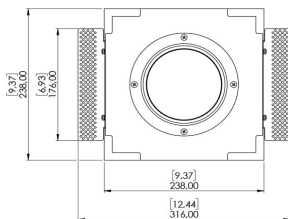
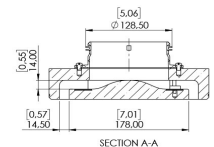
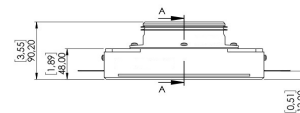
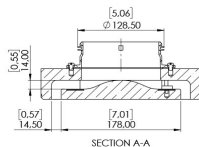
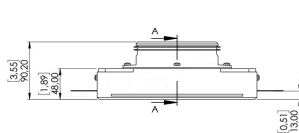
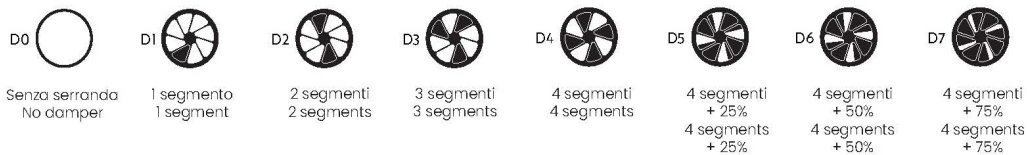

## EDSC-Q 100 MANDATA

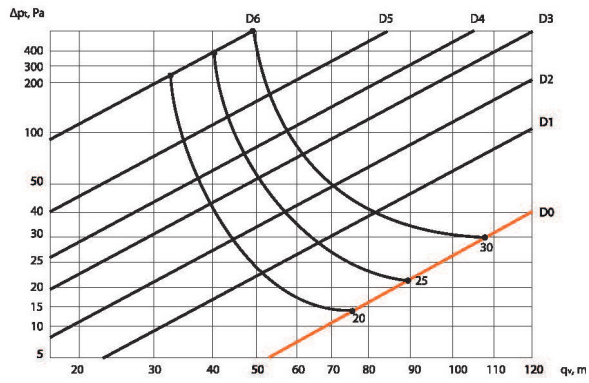

## EDSC-Q 100 RIPRESA

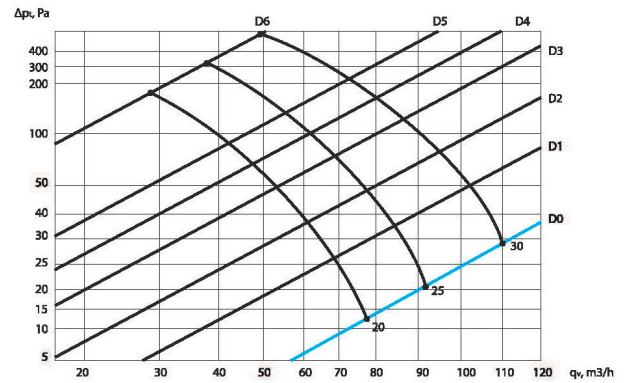

## EDSC-Q 125 MANDATA

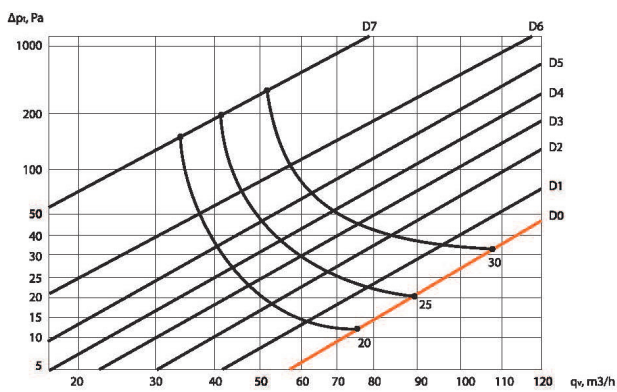

## EDSC-Q 125 RIPRESA

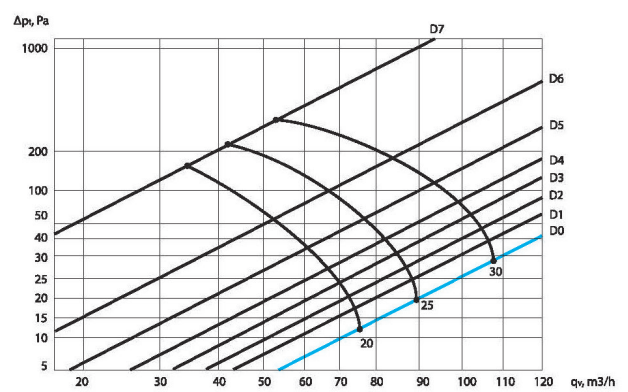

## EDSC-Q 100/125 LANCIO

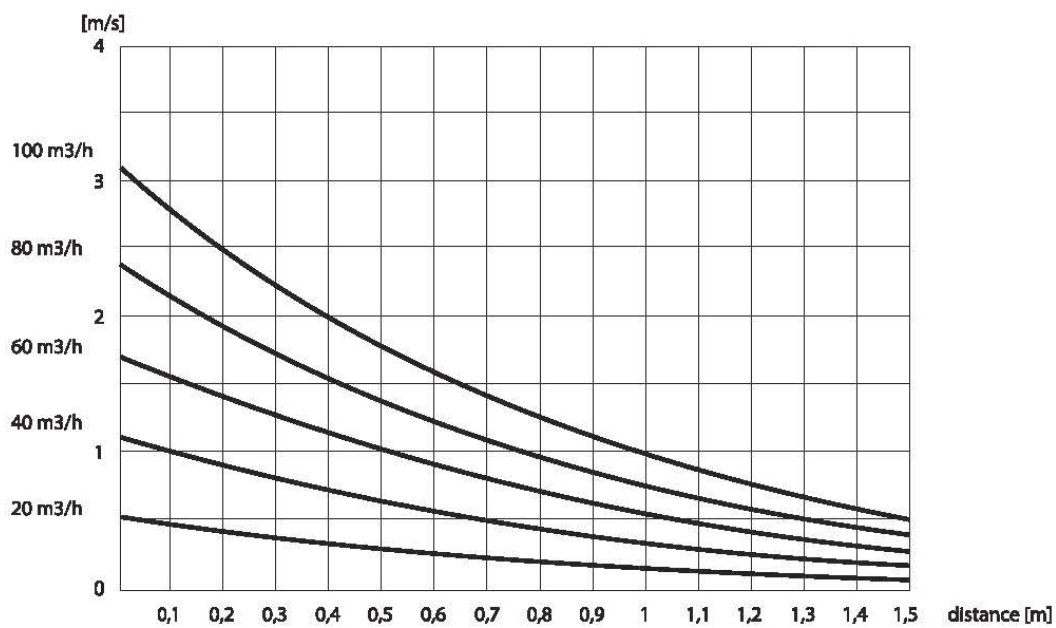



I diffusori sono provvisti di staffe di fissaggio

Sulla sinistra come installare le staffe su soffitti a singola lastra e a destra per installazione su doppia lastra

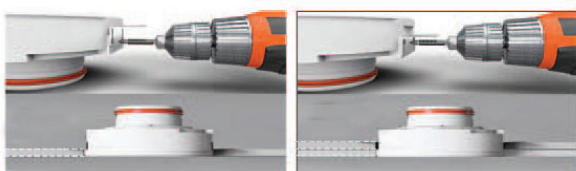

Forare la lastra di cartongesso e installare il diffusore tramite le staffe

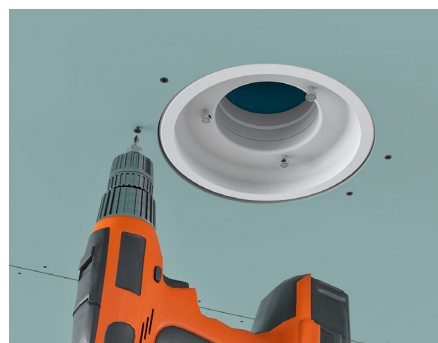

Dopo la rasatura il diffusore, avendo corpo in gesso, può essere verniciato e si può procedere all'installazione della serranda e del copriforo

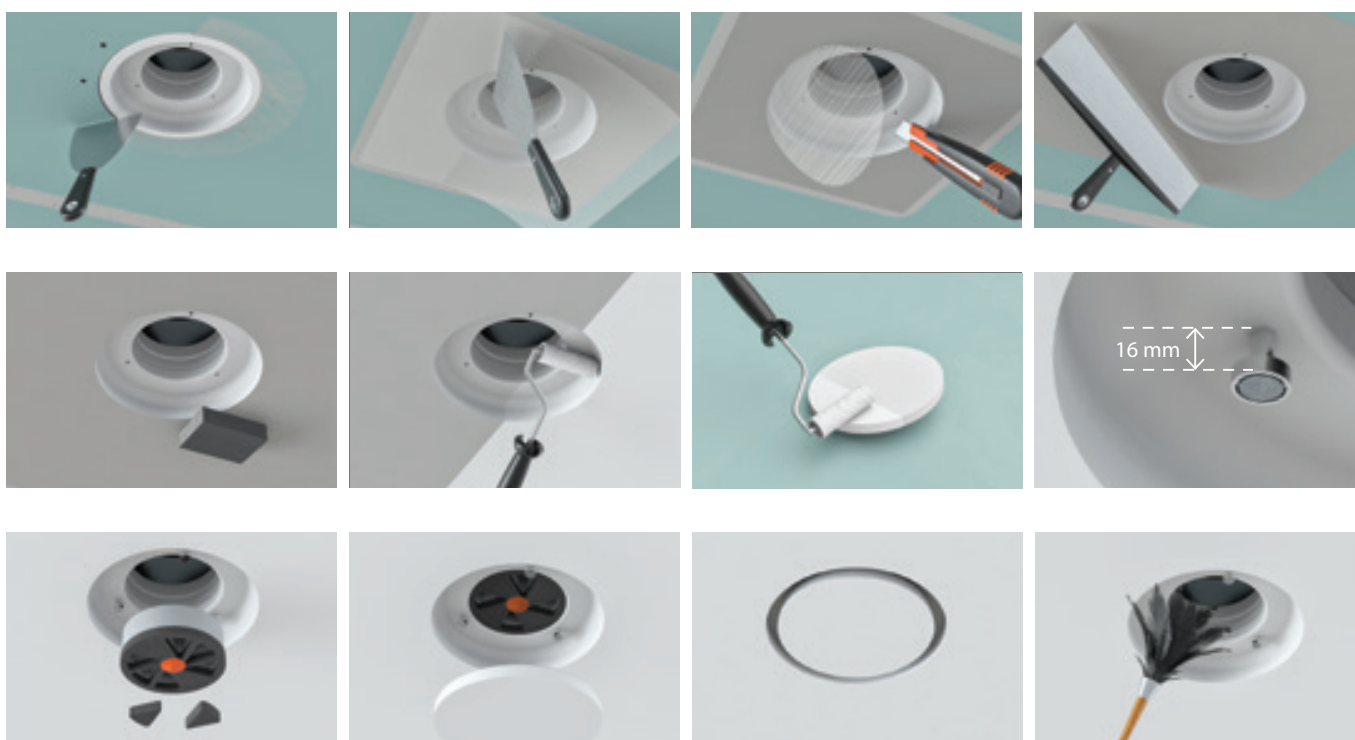



E' possibile utilizzare il plenum zincato EARS-PN, per connettere il diffusore a tubazioni HTPE

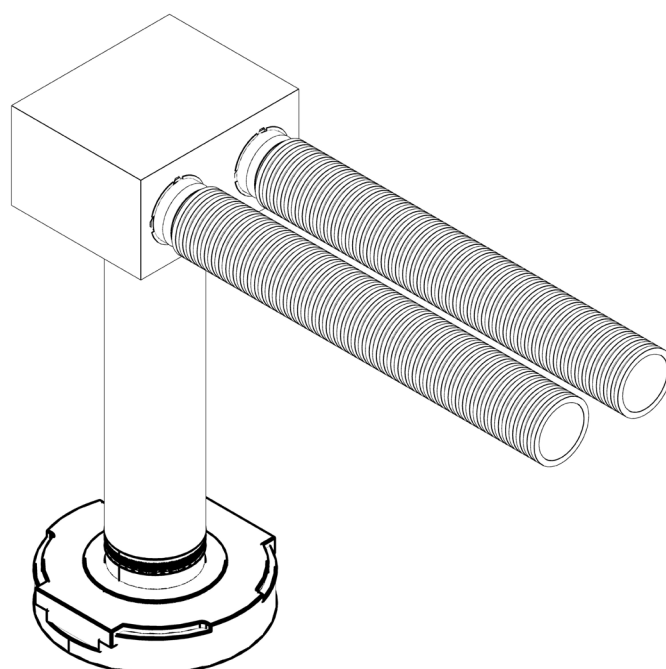

# NOMENCLATURA CODICE

Come ordinare

<b>EDSC</b>	<b>C</b>	<b>100</b>
↓	↓	↓
<b>EDSC</b> Diffusori a scomparsa per cartongesso	<b>C</b> : circolari; <b>CC</b> : circolari con effetto coanda; <b>Q</b> : quadrati;	<b>Diametro (mm)</b> 100 125 160 (solo per modello EDSC-C)



**Head quarter**

**ECOCLIMA SRL**  
Via Caduti di Russia, 19  
35010 Curtarolo - PADOVA - ITALY  
P. +39 049 9620344  
info@ecoclima.com

**Sales office Italy**  
info@ecoclima.com

**Sales office international**  
francesca@ecoclima.com

[ecoclima.com](http://ecoclima.com)



ISO 9001  
ISO 50001  
ISO 45001  
ISO 14001

Certified Management System